

Part Number:

KXA00050 and KXA00099
KXA00100 and KXA00099
KXA00145
KXA00146

Models:

Meteor 350cc MY20 Onwards

WARNING: Royal Enfield genuine accessories are designed to fit only the specific Royal Enfield motorcycle(s) that are specified above. They should not be fitted to any other type of motorcycle. Pay particular attention to the warnings and cautions contained in this instruction, failure to do so may result in an incorrect installation of the accessory which could result in an unsafe riding condition and possible accident. If in any doubt always seek help from your authorised Royal Enfield dealer.

WARNING: Before starting any accessory kit installation ensure the motorcycle is supported in a stable condition. Failure to support the motorcycle correctly could lead to motorcycle damage or personal injury.

WARNING: All fixings must be tightened to the torque values specified in this instruction. Failure to tighten fixings to the correct torque could result in an unsafe riding condition and possible accident.

CAUTION: Care should be taken when fitting any accessory kit. Incorrect handling of kit components or the use of incorrect tools could lead to component or motorcycle damage.

NOTE: The content of this instruction is subject to change at any time without notice or liability. Royal Enfield reserves the right to revise the information presented at any time.

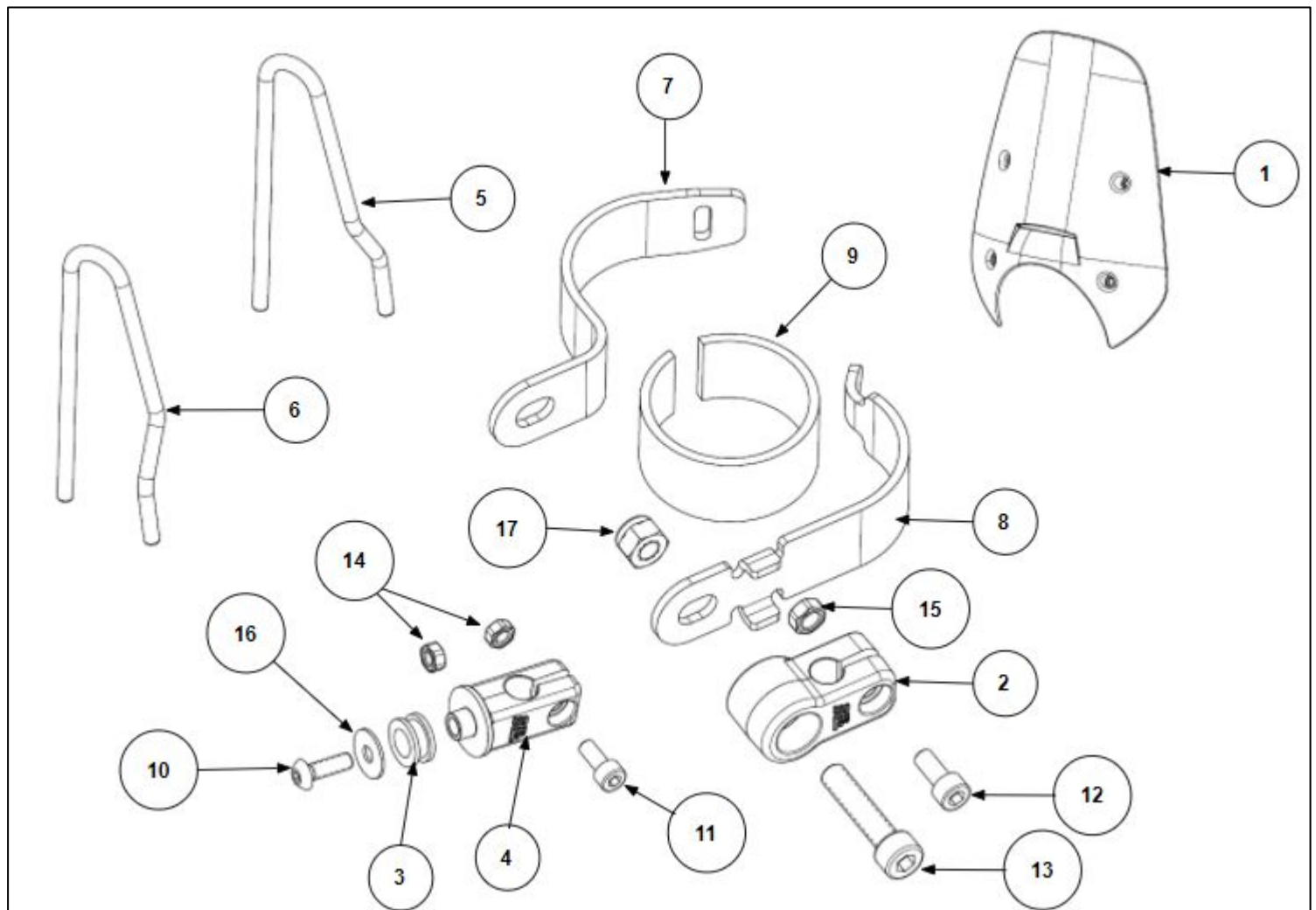

Item	Description	Qty
1	Touring Screen	1
2	Lower Mount	2
3	Rubber Grommet	4
4	Screen Mount Clamp	4
5	Touring Screen Mounting Bar RH	1
6	Touring Screen Mounting Bar LH	1
7	Fork Clamp Inwards	2
8	Fork Clamp Outwards	2
9	Rubber Sleeve	2
10	Bolt, M5 x 16	4
11	Bolt, M5 x 12	4
12	Bolt, M6 x 14	2
13	Bolt, M8 x 35	2
14	Nut, M5	8
15	Nut, M6	4
16	Washer, M5	4
17	Nyloc Nut, M8	2

1 Push fit 4 No. rubber grommets (3) into the touring screen (1)

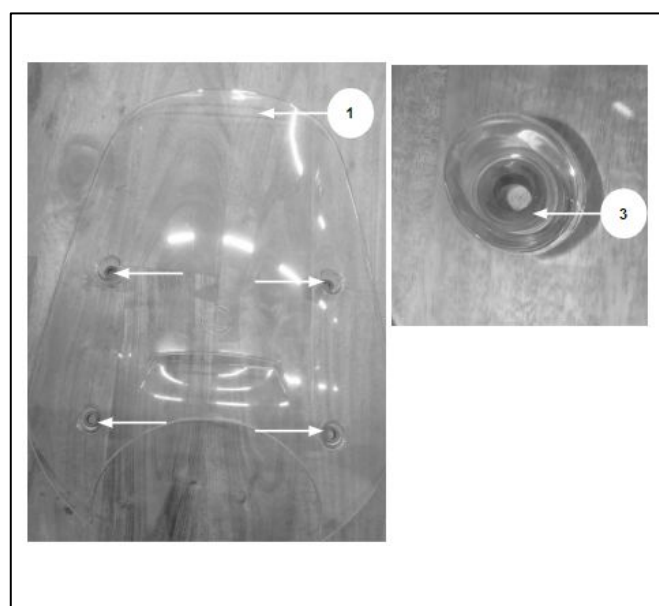

2 Loosely assemble the screen mount clamp (4) with an M5 bolt (12) and nut (14). Repeat this step with remaining 3 No. mount clamps.

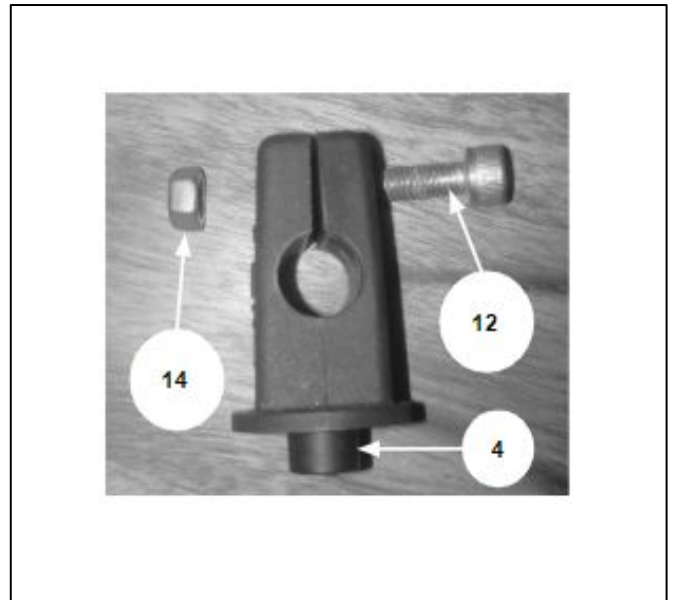

3 Push fit an M5 nut (14) into the pocket of the 4 No. screen mount clamps (4) and loosely assemble to the touring screen (1) through the rubber grommets (3) with an M5 bolt (10) and M5 washer (16).

Note: The 'R' branding should be visible when viewed from the side of the motorcycle.

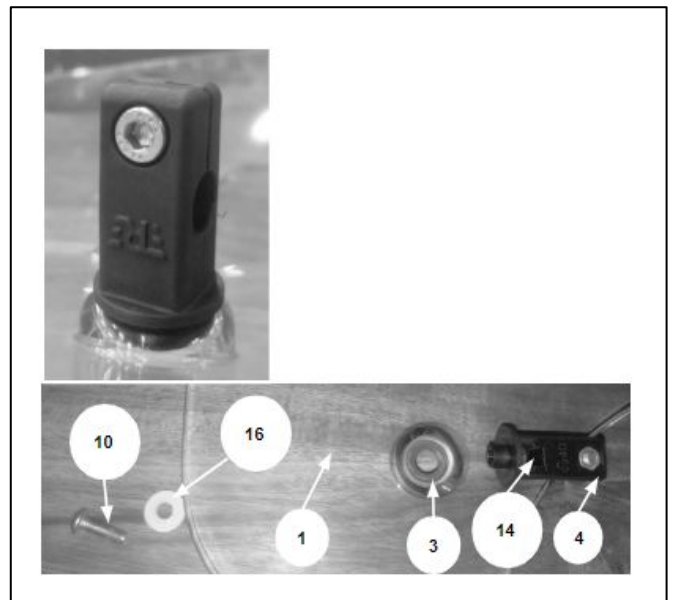

4 Slide the touring screen mount bars (5,6) into the screen mount clamps (4) and tighten the 4 No. M5 bolts (10) to **3Nm**.

	3mm hexagonal socket with torque wrench
--	---

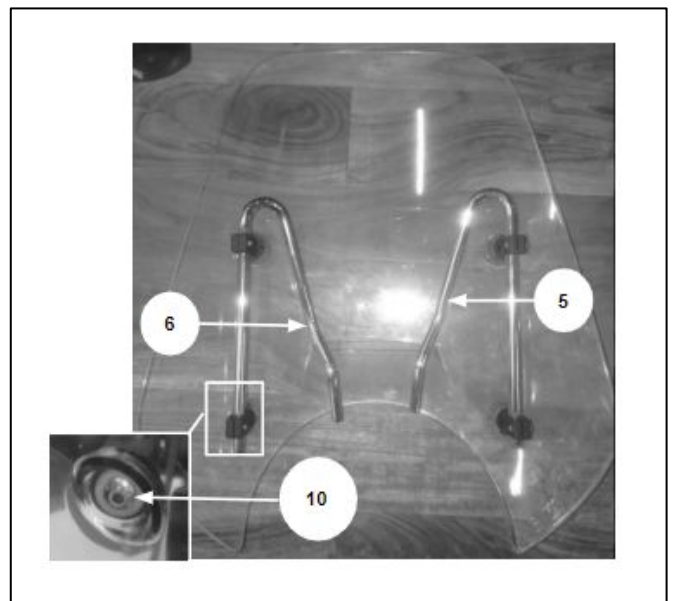

5 Mount rods orientation

1. Ensure the correct orientation of mount rods as shown in image (1).
2. Mount rods should not be mounted in wrong orientation, for example shown in the image (2).

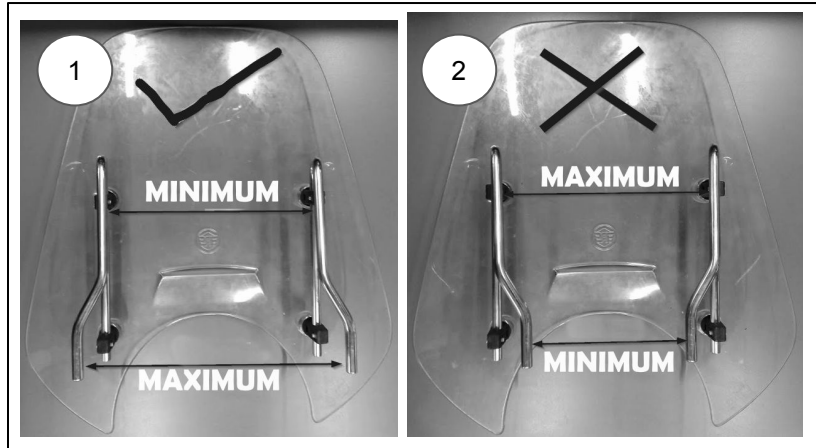

- 6 Ensure equal distance of 10mm is maintained on both sides of the mount rods as shown in the image.



- 7 Loosely assemble the lower mount (2) with an M6 bolt (12) and M6 nut (15). Repeat this step for the remaining lower mount.

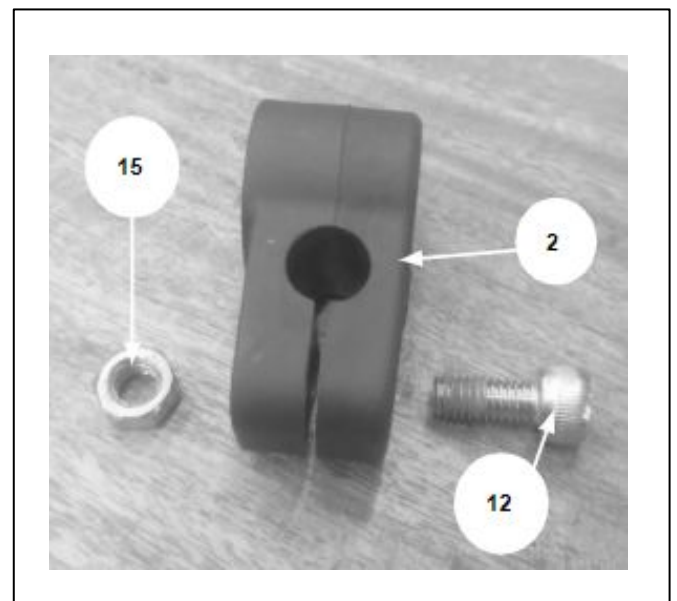

8 Loosely assemble the rubber sleeve (9), fork clamp inwards (7), fork clamp outwards (8) around the fork tube and assemble the lower mount (2) on the outside of the fork with an M8 bolt (13) and M8 nyloc nut (16). Repeat this step for the other fork.

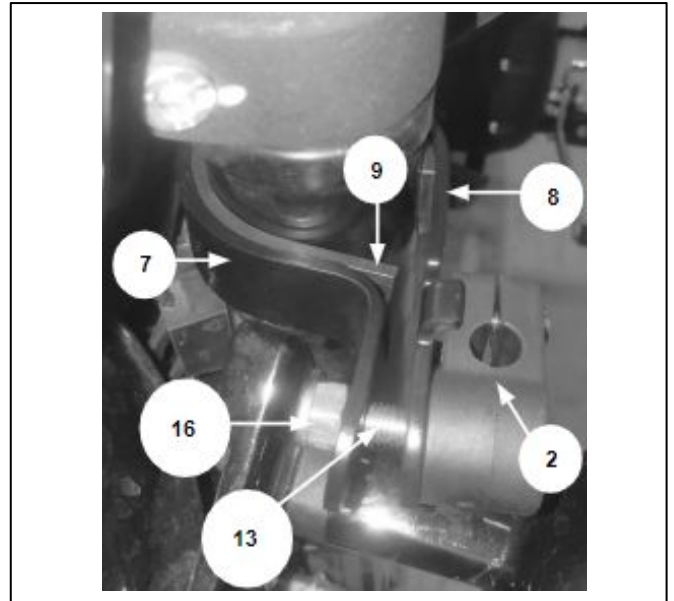

9 Align the fork clamp assembly so that it butts up to the top surface of the fork tube. Using the trafficator mount bracket as a guide, position the clamps parallel to the bracket and tighten the M8 nyloc nut to **25Nm**. Repeat this step for the other fork assembly.

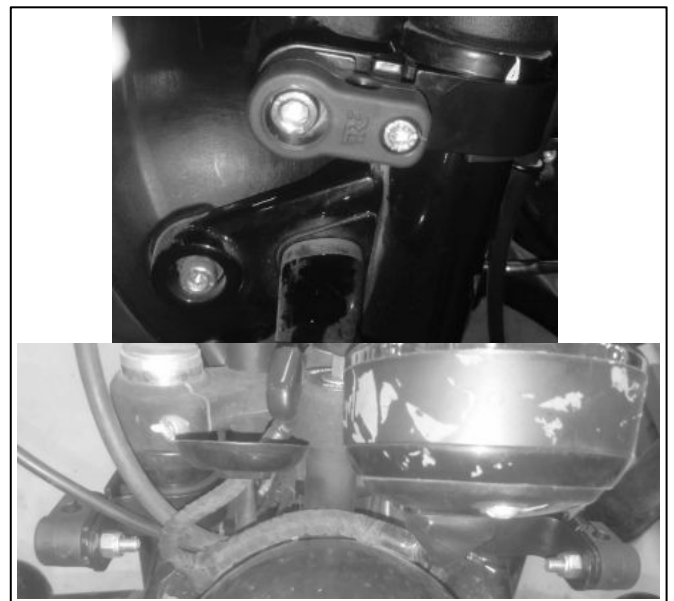

	6mm hexagonal socket with torque wrench
--	---

10 Slide the touring screen mount bars (5,6) into the lower mounts (2).

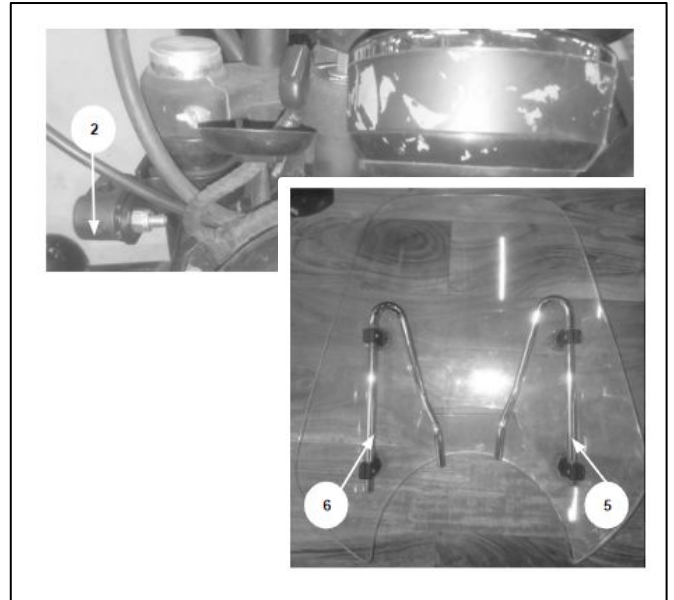

11 Position the touring screen (1) at the desired height. A minimum 10mm gap between the headlight bezel is recommended. Ensure that the screen is central to the bike then tighten 2 No. M6 bolts (12) to **4Nm**.

	5mm hexagonal socket with torque wrench
--	---

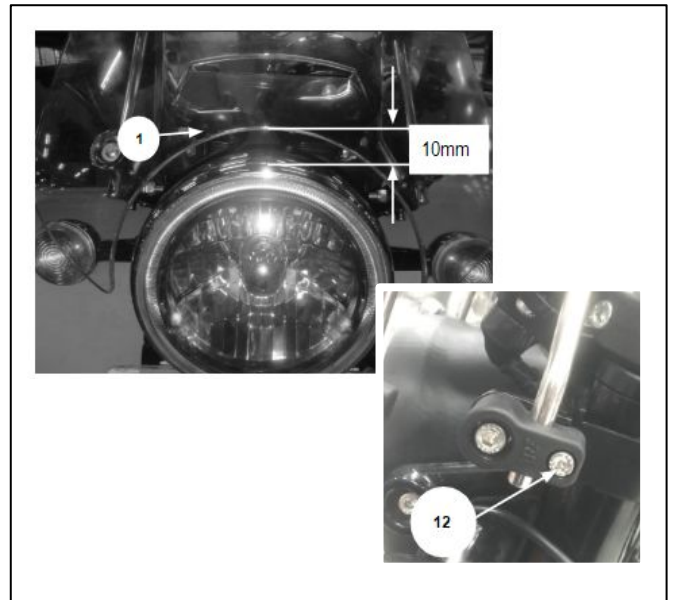

12 Tighten 4 No. M5 bolts (11) to **3Nm**.

	3mm hexagonal socket with torque wrench
--	---

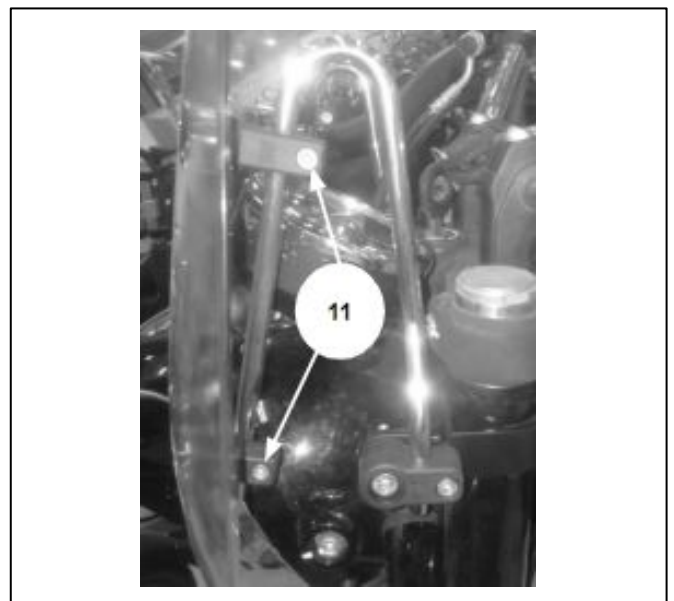



WARNING: After fitting any genuine Royal Enfield accessory always ride the motorcycle with caution and allow time to become familiar with any change in the motorcycle handling characteristics. Failure to become familiar with any change in the motorcycle handling characteristics may cause the motorcycle to become unstable and result in an accident.