

**Part Number:**  
KXA00442

**Models:**  
Himalayan (452cc only)  
Bear 650

**WARNING:** Royal Enfield genuine accessories are designed to fit only the specific Royal Enfield motorcycle(s) that are specified above. They should not be fitted to any other type of motorcycle. Pay particular attention to the warnings and cautions contained in this instruction, failure to do so may result in an incorrect installation of the accessory which could result in an unsafe riding condition and possible accident. If in any doubt always seek help from your authorised Royal Enfield dealer.

**WARNING:** Before starting any accessory kit installation ensure the motorcycle is supported in a stable condition. Failure to support the motorcycle correctly could lead to motorcycle damage or personal injury.

**WARNING:** All fixings must be tightened to the torque values specified in this instruction. Failure to tighten fixings to the correct torque could result in an unsafe riding condition and possible accident

**CAUTION:** Care should be taken when fitting any accessory kit. Incorrect handling of kit components or the use of incorrect tools could lead to component or motorcycle damage.

**NOTE:** The content of this instruction is subject to change at any time without notice or liability. Royal Enfield reserves the right to revise the information presented at any time.

Parts Supplied: KXA00442



Item	Description	Qty
1	Tail pack	1
2	Mount strap long, left hand	1
3	Mount strap long, right hand	1
4	Mount strap short, left hand	1
5	Mount strap short, right hand	1

## For Himalayan models - fitment to luggage rack

**1** Locate the rear sleeve (1) onto the luggage rack (2).

Note: The handle is positioned towards the rear of the motorcycle (3).

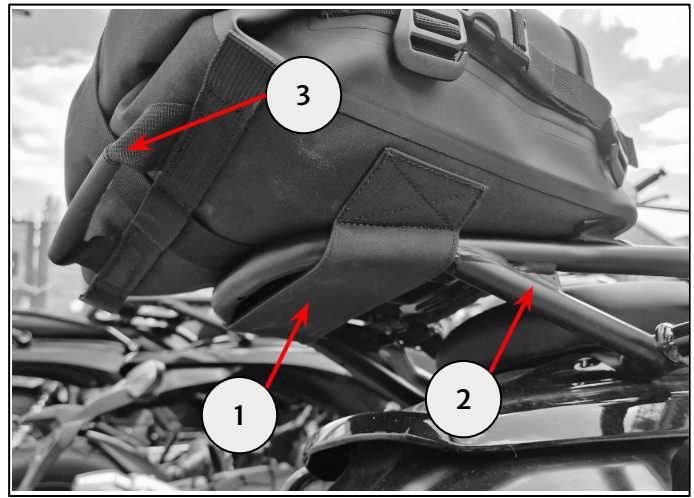

**2** Wrap the long right hand mounting strap (1) around the front left hand luggage rack mounting boss (2).

Repeat for the right hand mounting boss with the remaining long mounting strap.

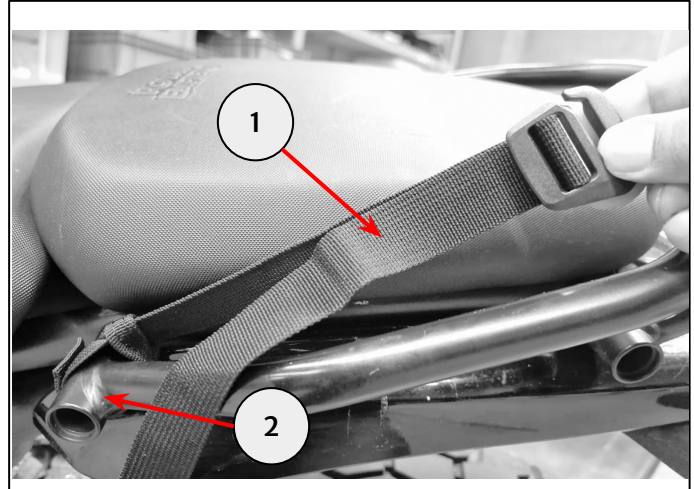

**3** Locate each G hook (1) through the webbing loop (2) on the underside of the Tail Pack and tension both mounting straps (3).

Securely tie any excess strap back around itself.

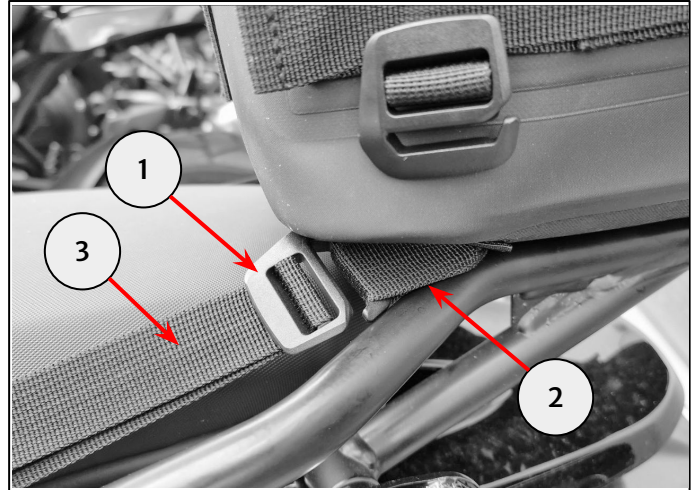

## For Himalayan models - fitment to pillion seat

**4** Remove the luggage rack mount plate (1) or top box mount plate (2) if fitted. Retain the fixings and plate for reuse.

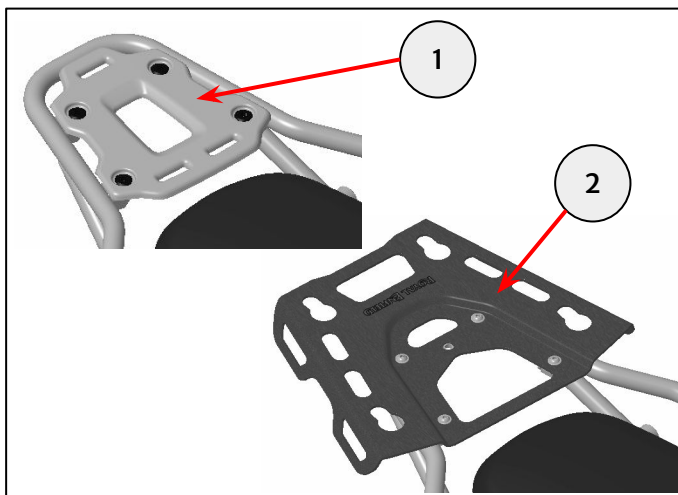

**5** Wrap the short left hand mounting strap (1) around the right hand luggage rack tube as shown.

Repeat for the left hand side with the remaining short mounting strap (2).

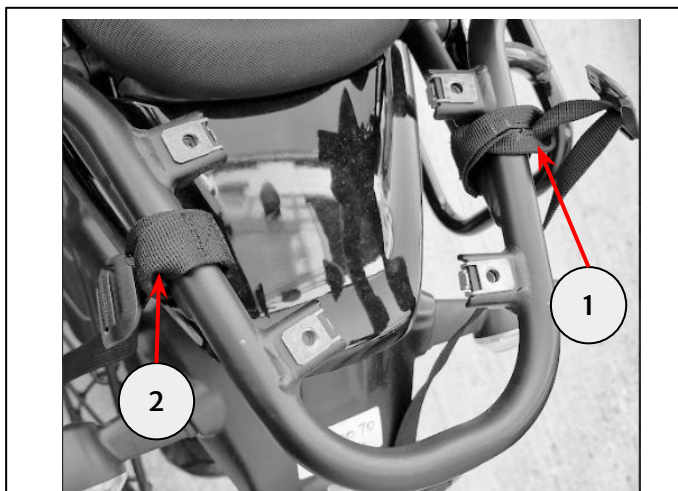

**6** Refit the mount plate using the fixings removed in step 4.

Luggage mount plate (1): Tighten fixings to **10Nm**.

Top box mount plate (2): Tighten to **torque specified below**.

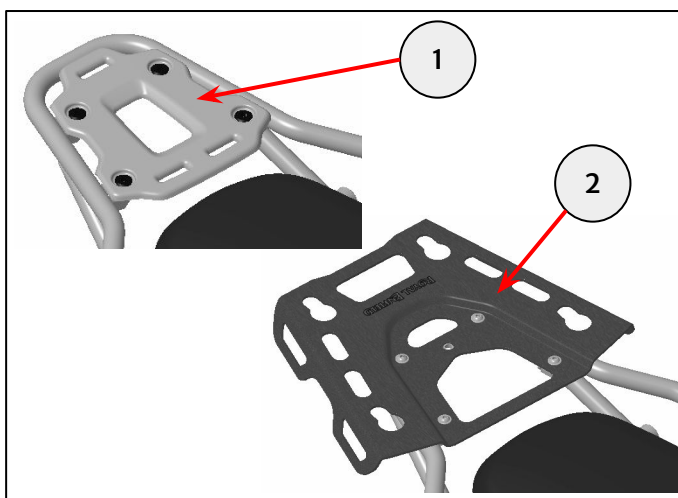

4mm hexagonal bit and torque wrench (**8Nm**)  
-or-  
8mm socket and torque wrench (**13Nm**)

**7** Wrap the long left hand mounting strap (1) around the right hand centre stand handle (2).

Repeat for the left hand centre stand handle with the remaining long mounting strap.

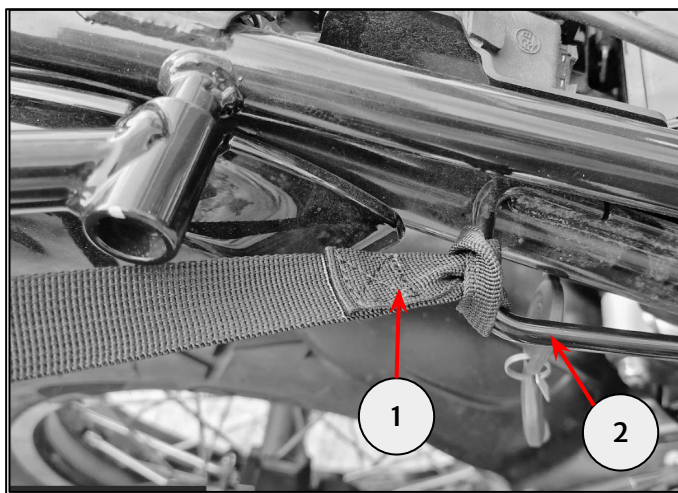



**8** Position the Tail Pack sideways on the pillion seat. Locate each G hook (1) into the webbing loops (2) on the underside of the Tail Pack.

Tension all four straps and securely tie any excess strap back around itself.

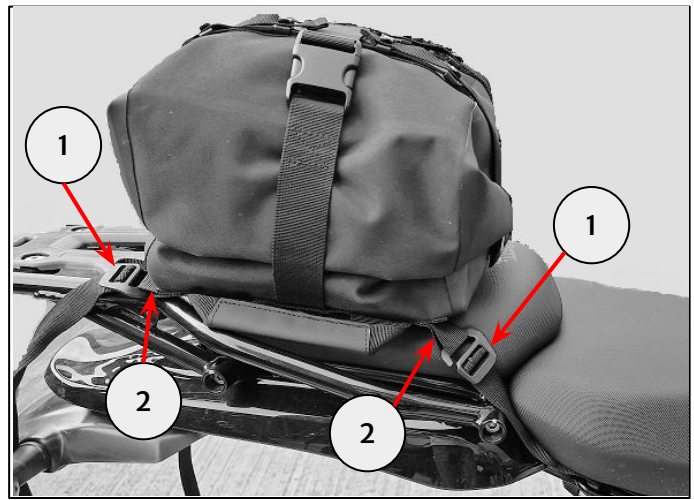

## For Bear 650 models

**9** Remove the seat as described in the Owner's Manual.

Wrap the short left hand mounting strap (1) around the right hand rear frame tube (2) as shown.

Repeat for the left hand side with the remaining short mounting strap.

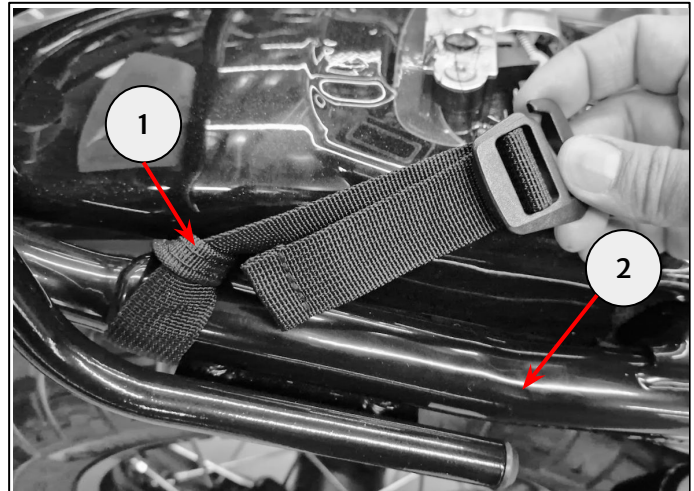

**10** Wrap the long left hand mounting strap (1) around the right hand frame tube (2), forward of the down tube (3) as shown.

Repeat for the left hand side with the remaining long mounting strap.

Refit the seat as described in the Owner's Manual.

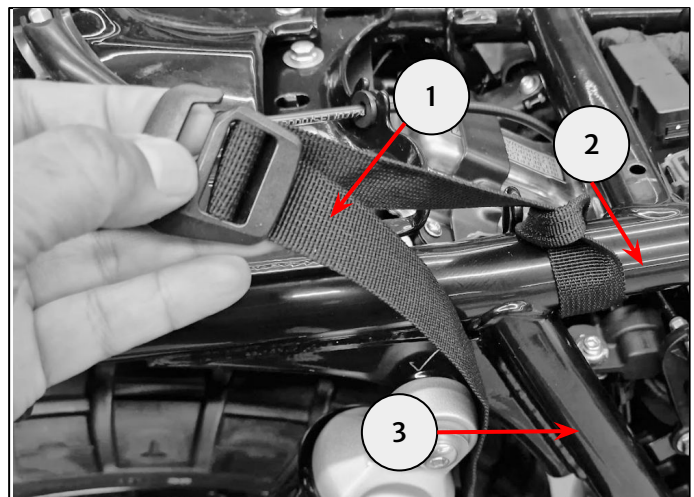

**11** Position the Tail Pack sideways over the seat. Locate each G hook (1) into the webbing loops (2) on the underside of the Tail Pack.

Tension all four straps and securely tie any excess strap back around itself.



## For all models

**12** Close the Tail Pack opening (1), ensuring the opening is folded together as shown, and secure using the internal velcro tabs (2).

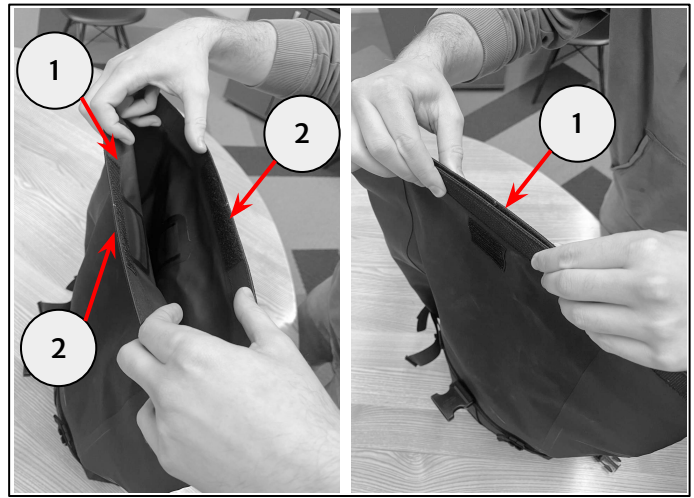

**13** Roll down the opening tightly towards the rear face (2) to take up excess material. Ensure the velcro tab by the opening (3) and main body (4) are secured together.

Roll tightly a minimum of 3 complete rolls or until secure.

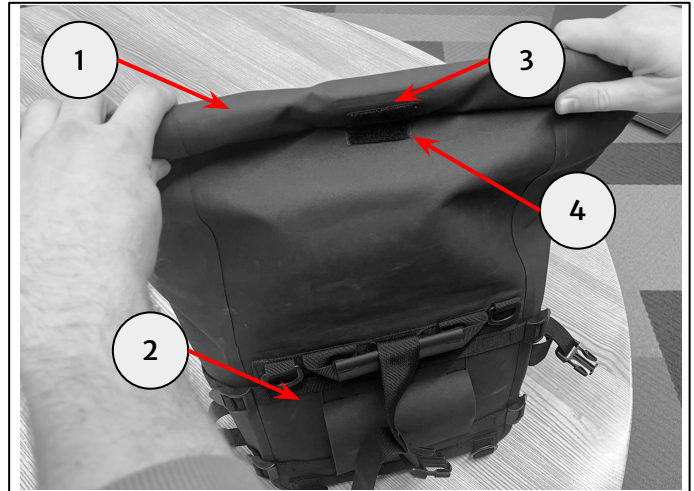

**14** Attach the side clip (1) to the buckle (2) and fully tighten as shown. Repeat for both sides.

Secure excess strap through the elasticated loop provided (3).

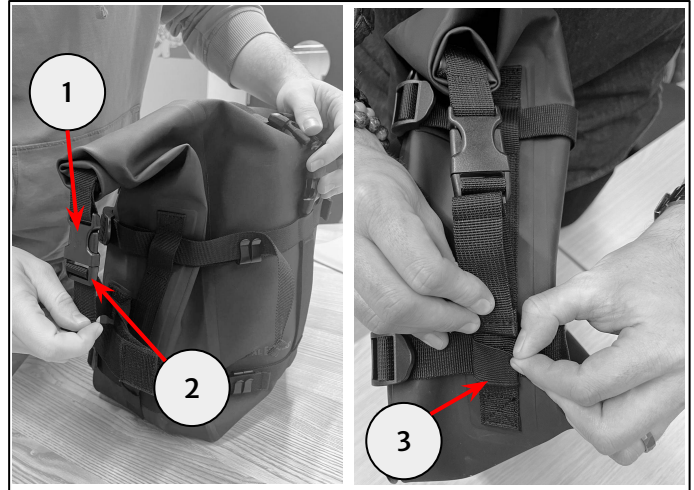

**15** Place the strap (1) over the Tail Pack and secure clip (2) to the buckle (3) as shown.

Fully tighten and secure the excess strap through the elasticated loop provided (4).

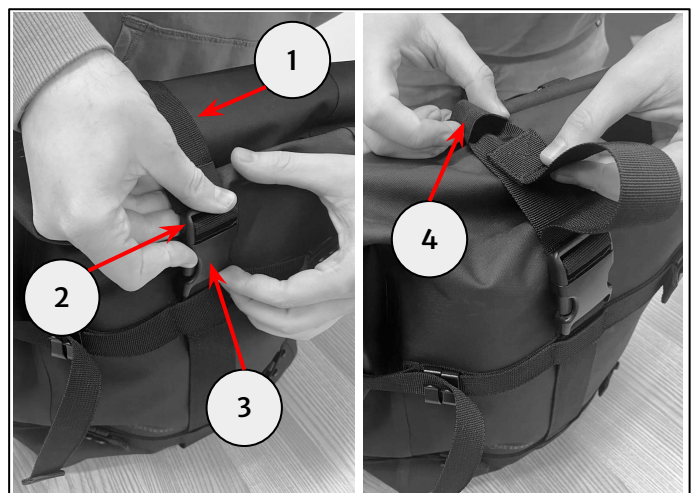

**16** Tighten all horizontal straps (1), and secure excess straps using the clips (2) provided.

Note: Repeat for all four straps on the front of the Tail Pack.



 **WARNING:** The maximum safe load for the bag is 3kg (6.6 lbs). Never exceed this loading limit as this may cause the motorcycle to become unstable and could lead to motorcycle damage or personal injury.

 **WARNING:** Always ensure the mounting straps are correctly tensioned before riding the motorcycle. Failure to tighten the straps could result in an unsafe riding condition and possible accident.

 **CAUTION:** Use of chemicals or high-pressure spray washers is not recommended for cleaning and may damage the bag. To help maintain its appearance, clean the bag using a sponge or cleaning cloth with low alkaline soap and water.